

M12 FEMALE 0° LED

PVC 3X0.34 GRAY, UL/CSA 5m

Female straight

M12, 3-pole

2× LED (PNP)

Art-No. 7005 - M12 Lite - (plastic hexagonal screw) on request

Plastic housings with good resistance against chemicals and oils.

The resistance to aggressive media should be individually tested for your application. Further details on request.

Further cable lengths on request.

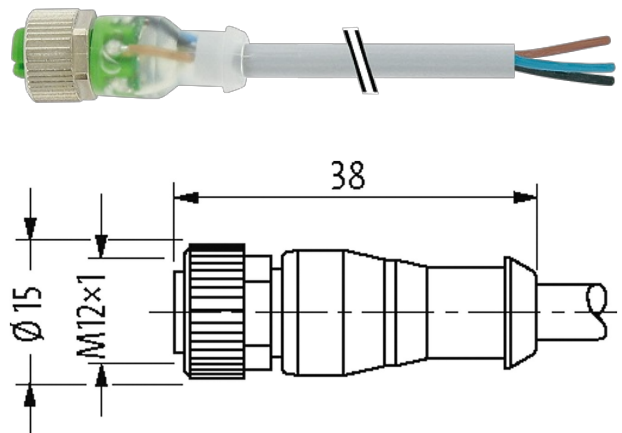
Illustration

Product may differ from Image

Approvals

* only for products with UL/CSA approved cable

cCSAus

Form

Form 12261

General data

Standards	DIN EN 61076-2-101 (M12)
Pollution Degree	3
Temperature range	-25...+85 °C, depending on cable quality

Cables

No./diameter of wires	3× 0.34 mm ²
Wire isolation	PVC (br, bl, bk)
Material (jacket)	PVC (UL/CSA)
Outer Ø	4.6 mm ±5%
Bend radius (moving)	10× outer Ø
Temperature range (fixed)	-30...+80 °C
Temperature range (mobile)	-5...+80 °C
Cable identification	213
Cable Type	1 (PVC)
Approval (cable)	UL (AWM-Style 2464/1731), CSA

Cable weight [g/m]	34,10
Material (wire)	Cu wire, bare
Resistor (core)	max. 60 Ω /km (20 °C)
Single wire \varnothing (core)	0.15 mm
Construction (core)	19x 0.15 mm (multi-strand wire class 5)
Diameter (core)	3x 0.34 mm ²
AWG	similar to AWG 22
Material (wire isolation)	PVC
Material property (wire isolation)	CFC-, cadmium-, silicone- and lead-free
Shore hardness (wire isolation)	45 \pm 5 D
Wire- \varnothing incl. isolation	1.25 mm \pm 5%
Color/numbering of wires	br, bk, bl
Stranding combination	3 wires twisted
Shield	no
Material (jacket)	PVC
Material property (jacket)	CFC-, cadmium-, silicone- and lead-free
Shore hardness (jacket)	85 \pm 5 A
Outer- \varnothing (jacket)	4.6 mm \pm 5%
Color (jacket)	gray
chemical resistance	good resistance to oil, gasoline and chemicals
thermal resistance	flame retardant UL 1581 VW1 / CSA FT1
Nominal voltage	UL 300 V AC
Test voltage	2000 V AC
Current load capacity	to DIN VDE 0298-4
Temperature range (fixed)	-30...+80 °C
Temperature range (mobile)	-5...+80 °C
Bend radius (fixed)	5x outer \varnothing
Bend radius (moving)	10x outer \varnothing
Jacket Color	gray

Technical Data

Operating voltage	24 V DC \pm 25%
Operating voltage (only UL listed)	max. 30 V DC
Rated surge voltage	0.8 kV
Operating current per contact	max. 4 A
Material group	IEC 60664-1, category I
Coding	A-coded
Locking of ports	Screw thread (M12x1 mm) recommended torque 0.6 Nm, self-securing
Compression gland	M12 (SW13)
Protection	IP65, IP66K, IP67 inserted and tightened (EN 60529)
Locking material	Zinc die casting, matte nickel plated
Material	PUR
suitable for corrugated tube (internal \varnothing)	10 mm

Commercial data

country of origin	CZ
customs tariff number	85444290
EAN	4048879210355
eClass	27279218
Packaging unit	1

Sketch

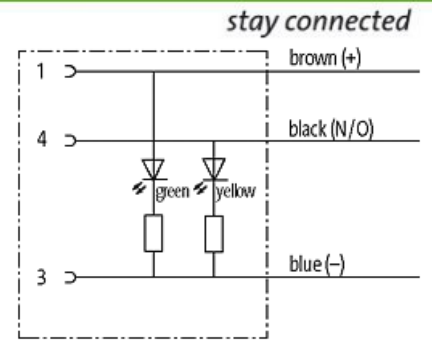

Female

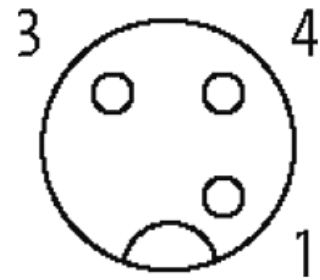

Product may differ from Image